

SYSTEM BOARD
D1214/D1215/D1216

**ADDITIONAL TECHNICAL
MANUAL**

Are there ...

... any technical problems or other questions you need clarified?

Please contact:

- Our Hotline:
 - Mo-Fr: 8 a.m. - 6 p.m.
 - Sat: 9 a.m. - 2 p.m.
 - Tel.: ++49 (0) 180 3777 005
- your sales outlet

The latest information on our products, tips, updates, etc., can be found on the Internet under:
<http://www.fujitsu-siemens.com/mainboard>



Dieses Handbuch wurde auf Recycling-Papier gedruckt.
This manual has been printed on recycled paper.
Ce manuel est imprimé sur du papier recyclé.
Este manual ha sido impreso sobre papel reciclado.
Questo manuale è stato stampato su carta da riciclaggio.
Denna handbok är tryckt på recyclingpapper.
Dit handboek werd op recycling-papier gedrukt.

Herausgegeben von/Published by
Fujitsu Siemens Computers GmbH

Bestell-Nr./Order No.: **A26361-D1216-Z181-1-7619**

Printed in the Federal Republic of Germany

AG 0801 08/01

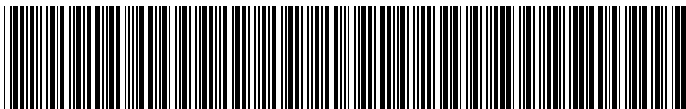

A26361-D1216-Z181-1-7619

**System Board
D1214/D1215/D1216**

Additional Technical Manual

August 2001 edition



Intel, Pentium and Celeron are registered trademarks of Intel Corporation, USA.

Microsoft, MS, MS-DOS and Windows are registered trademarks of Microsoft Corporation.

PS/2 and OS/2 Warp are registered trademarks of International Business Machines, Inc.

Magic Packet is a registered trademark of Advanced Micro Devices, Inc.

Rambus, RDRAM, and the Rambus Logo are registered trademarks of Rambus Inc. Direct Rambus, RIMM, SO-RIMM, and Direct RDRAM are trademarks of Rambus Inc.

All other trademarks referenced are trademarks or registered trademarks of their respective owners, whose protected rights are acknowledged.

Copyright © Fujitsu Siemens Computers GmbH 2001

All rights, including rights of translation, reproduction by printing, copying or similar methods, even of parts are reserved.

Offenders will be liable for damages.

All rights, including rights created by patent grant or registration of a utility model or design, are reserved. Delivery subject to availability.

Right of technical modification reserved.

Contents

Introduction.....	1
Features	1
Mechanics	3
Connectors	5
Power supply monitoring.....	5
Intrusion connector for case open detect for optional push-button (opener).....	5
Serial port 2 (COM 2).....	6
Front panel connector.....	7
Fan 2 connector.....	8
Wake On LAN (WOL) connector.....	8
USB port C, D.....	8
CD-ROM audio connector (internal).....	9
Auxiliary (MPEG, TV) audio connector (internal).....	9
Fan 1 connector.....	9
Configuration	10
Functions controlled by the configuration switch	10
Power	10
Power requirement	10
Power loadability.....	10
Documentation	11
Installing drivers	11
Upgrading main memory	11
Troubleshooting.....	12
Message BIOS update.....	12
The screen stays blank.....	12

Introduction



Depending on the configuration of your system board, some of the hardware components described may not be available.

You may find further information e. g. in the complete Technical Manual for the system board and in the description "BIOS Setup".

Further information to drivers is provided on the supplied drivers diskettes or on the "Drivers & Utilities" or "ServerStart" CD. For detailed information please look at chapter "[Installing drivers](#)". The latest BIOS version or drivers can be found on the internet under <http://www.fujitsu-siemens.com/en/service>.



Computer system boards and components contain very delicate IC chips. To protect them against damage caused by static electricity, you must follow these precautions:

- Use a grounded wrist strap.
- Unplug your computer before you remove any part of the casing.
- Place the system board and the components on a grounded antistatic pad whenever you remove them from the computer.

Hold components by the edge, do not touch any pins or connectors on them.

Once you have installed the system board, you should remove the battery protection (i.e. the thin plastic plate between battery and contact spring).

Features

The table shows assembly versions of this system board as example.

Features	D1214-A	D1215-A	D1216-B
Chipset	Intel 815E		
Board Size	μ-ATX	μ-ATX	μ-ATX
VGA onboard (Intel 815E)	✓	✓	-
Audio onboard (AC '97)	✓	✓	✓
LAN onboard / with Alert-on-LAN	✓ / -	✓ / ✓	- / -
Thermal Management onboard	-	✓	-
System Monitoring onboard	-	✓	-
Fujitsu Siemens Keyboard Power Button Support	-	✓	-
Buzzer onboard / int. Speaker Support	✓ / -	- / ✓	✓ / -
Internal Connectors			
DIMM Sockets (SDRAM)	2	2	2
AGP Slot (1/2/4x, 32Bit, 66 MHz)	1	1	1
PCI Slots (32Bit, 33 MHz, 5 V and 3.3 V)	3	3	3
ISA Slot	-	-	-
ACR Slot	-	-	-
CNR Slot (Type A)	-	-	1
AMR Slot	-	-	-
IDE Interfaces (Ultra DMA/100)	2	2	2
Floppy Interface (up to 2.88 MB)	1	1	1
CD / AUX Audio Input	1 / 1	1 / 1	1 / 1
Wake-on-LAN	1	1	1
Int. Serial Port / with SmartCard Support	1 / ✓	1 / ✓	1 / -
USB Connectors int. / shared with CNR	2 / -	2 / -	2 / 1
External Connectors			
VGA	1	1	-
Audio Mic. / in / out (2 x 0.5 W / 8 Ω)	1	1	1
Game/MIDI	1	1	1
LAN (RJ-45)	1	1	-
PS/2 Mouse/Keyboard	1	1	1
Ext. Serial Port (FIFO, 16550 compatible)	1	1	1
Parallel Port (EPP/ECP)	1	1	1
USB Connectors external	2	2	2

Mechanics

Layout

µATX 9.6" x 8" (243.84 mm x 203.2 mm)

Some of the following connectors are optional and may therefore not be included on your system board.

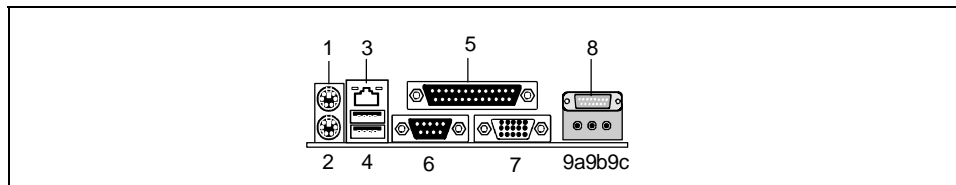

- 1 = PS/2 mouse port
- 2 = PS/2 keyboard port
- 3 = LAN port
- 4 = USB ports A and B
- 5 = Parallel port
- 6 = Serial port 1

- 7 = VGA port
- 8 = Game/Midi port
- 9a = Audio Line-Out
Headphones
- 9b = Audio Line-In
- 9c = Audio Micro-In

The components and connectors marked are not necessarily present on the system board.

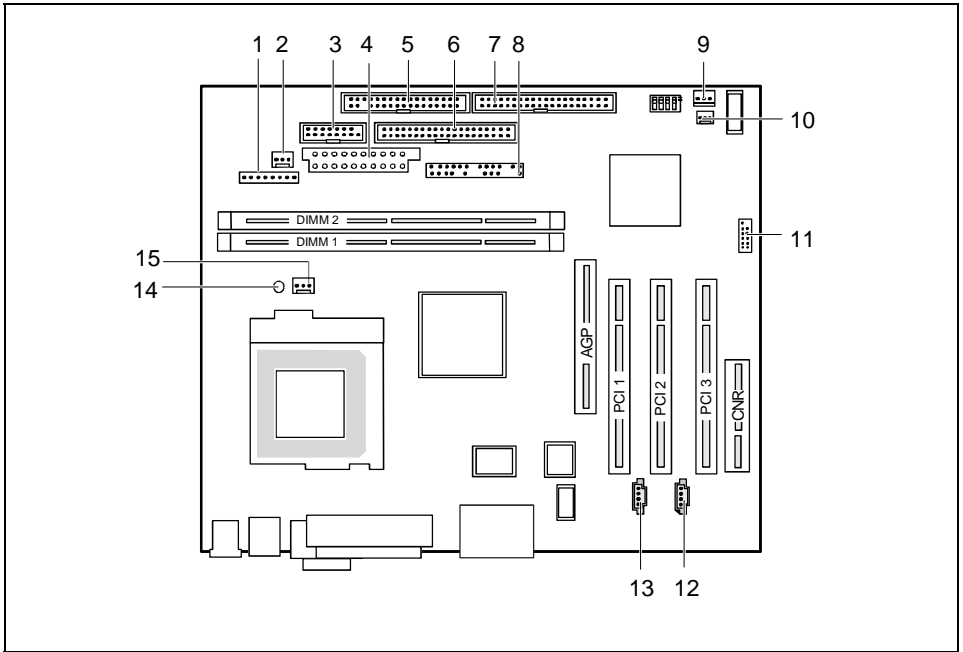

1 = Power supply monitoring

2 = Cover monitoring

3 = Serial port 2

4 = Power supply

5 = Floppy disk drive

6 = IDE drives 3 and 4 (secondary)

7 = IDE drives 1 and 2 (primary)

8 = Connector for control panel

9 = Fan 2 (e. g. for the system fan - supervised) *

10 = Wake On LAN

11 = USB ports C / D

12 = CD audio input

13 = AUX audio input

14 = Voltage indicator

15 = Fan 1 (e. g. for the processor)

The components and connectors marked are not necessarily present on the system board.

*) only for speed controllable fans (3 pin connector), for 2 pin processor fans use Fan2 connector only.

Connectors



Some of the following connectors are optional!

Power supply monitoring

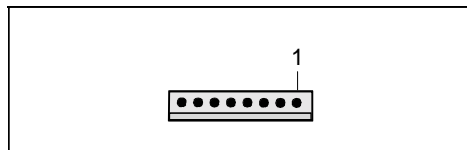

Pin	Signal
1	Monitor on
2	PS FAN control (low asserted)
3	PS FAN full on (low asserted)
4	PS FAN pulse
5	SMB CLK
6	SMB DATA
7	VCC EEPROM
8	GND

Intrusion connector for case open detect for optional push-button (opener)

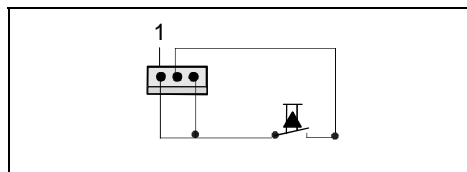

Pin	Signal
1	GND
2	Case open (low asserted)
3	Intrusion switch present (low asserted)

Serial port 2 (COM 2)

external via optional cable

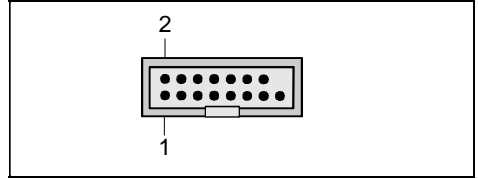

Pin	Signal	Pin	Signal
1	DCD 2	2	DSR 2
3	SIN 2	4	RTS 2
5	SOUT 2	6	CTS 2
7	DTR 2	8	PC_On_Strobe (TTL - Signal, low asserted)
9	GND	10	VCC Auxiliary
11	EXT SMI (TTL - Signal, low asserted)	12	VCC
13	RESET (TTL - Signal, low asserted)	14	GND
15	GND	16	Key

Front panel connector

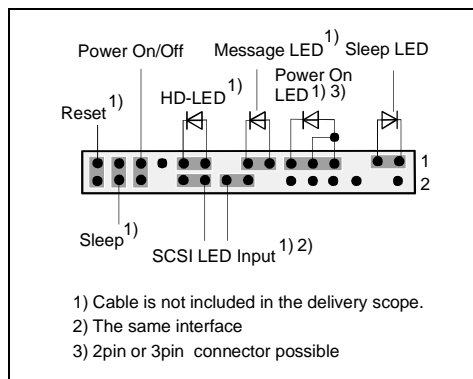

Pin	Signal	Pin	Signal
1	Sleep LED (Cathode)	2	Not connected
3	Sleep LED (Anode)	4	Key
5	Key	6	GND
7	PowerON_LED (Anode)	8 ¹⁾	VCC or GND
9	PowerON_LED (Anode)	10	Key pin
11	PowerON_LED (Cathode)	12	Key pin
13	Message_LED (Anode)	14	Key
15	Message_LED (Cathode)	16	Not connected
17	Key	18	SCSI LED input (low asserted)
19	HD_LED (Anode)	20	SCSI LED input (low asserted)
21	HD_LED (Cathode)	22	Not connected
23	GND	24	Key
25	Power button (low asserted)	26	GND
27 ²⁾	reserved	28	GND
29	Reset button (low asserted)	30	GND

1) Pin 8 is connected to VCC if audio is not onboard.

Pin 8 is connected to GND if audio is onboard.

2) The sleep button (optional) functions only for operating systems with APM (not with ACPI).

Fan 2 connector

(system fan - supervised)

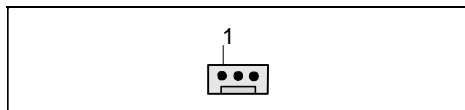

Pin	Signal
1	GND
2	+12 V
3	Fan sense

Wake On LAN (WOL) connector

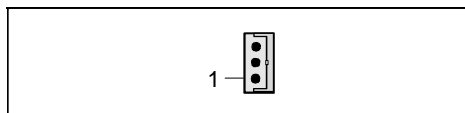

Pin	Signal
1	VCC Auxiliary
2	GND
3	Wake pulse (high asserted)

USB port C, D

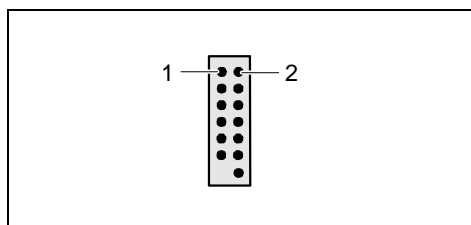

Pin	Signal	Pin	Signal
1	VCC Dual (fused max. 500mA and power supervision with over current detection)	2	Shield GND
3	Data negative	4	GND
5	Data positive	6	Data positive
7	GND	8	Data negative
9	Shield GND	10	VCC Dual (fused max. 500mA and power supervision with over current detection)
11	Key	12	Power supply on (CCR on) (max. 1 second low pulse)

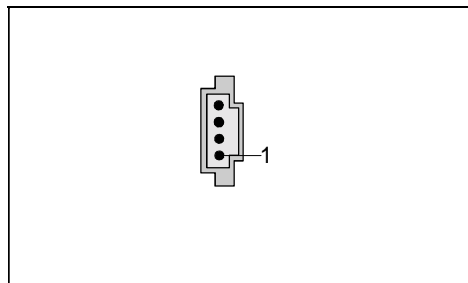
CD-ROM audio connector (internal)

Pin	Signal
1	Left CD audio input
2	CD GND
3	CD GND
4	Right CD audio input

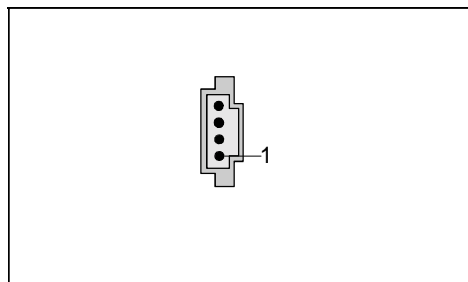
Auxiliary (MPEG, TV) audio connector (internal)

Pin	Signal
1	Left AUX audio input
2	Analog GND
3	Analog GND
4	Right AUX audio input

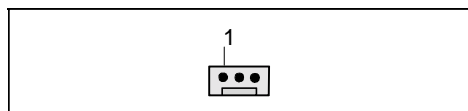
Fan 1 connector

Pin	Signal
1	GND
2	Controlled fan voltage (0 V / 6...12 V)
3	Fan sense

Configuration

Functions controlled by the configuration switch

Function	SKP	RCV	FWP	PSS
Password skip	on	X	X	X
Off	off	X	X	X
Recovery BIOS	X	on	X	X
Off	X	off	X	X
Floppy write protect	X	X	on	X
Off	X	X	off	X
Low auxiliary power supply (<2 A)	X	X	X	on
High auxiliary power supply	X	X	X	off

PSS must be switched on for systems with not enough 5 V auxiliary power for all its self powered wake devices (WakeOnLAN, USB, PCI) in S3-S4.

Power

Power requirement

Source	Voltage	Maximum variation	Maximum current	Comment
Main power supply	+5.0 V	±5 %	15 A	
Main power supply	+12 V	±5 %	350 mA	
Main power supply	-12 V	±10 %	200 mA	
Main power supply	+3.3 V	±5 %	4 A	
Auxiliary power supply	+5.0 V	±5 %	2 A	

Power loadability

Fuse number	Maximum fuse current	Function	Maximum function current
1	750 mA	Keyboard port	Not specified
		Mouse port	Not specified
		Game port	Not specified
2	500 mA	Universal serial bus (USB) Port A	500 mA
3	500 mA	Universal serial bus (USB) Port B	500 mA

Documentation

- ▶ Insert the "Drivers & Utilities" CD.
- ▶ If the CD does not start automatically, run the *START.EXE* file in the main directory of the CD.
- ▶ Select your system board or your device.
- ▶ Select *Documentation*.
- ▶ Select - *Technical Manuals*
- ▶ Select - *Technical Manuals (BIOS)*



You may have to install the Acrobat Reader - Software on the CD-ROM (path: utls/acrobat) before reading!

For more details please read the according readme.txt files.

Installing drivers

- ▶ Insert the "Drivers & Utilities" CD.
- ▶ If the CD doesn't start automatically call the *START.EXE* file in the main directory of the CD.
- ▶ If the system board list is displayed select the system board or select under *Driver* the operating system used and the audio and video drivers.

Upgrading main memory

Support: The system needs at least one module.

Size: From 32 Mbytes up to 512 Mbytes SDRAM

Technology: PC100 or PC133 unbuffered DIMM modules.
168 pin, 3.3 V, 64 bit, 72 bit (with ECC), SDRAM
2 M, 4 M, 8 M, 16 M and 32 M x 64 bit
2 M, 4 M, 8 M, 16 M and 32 M x 72 bit

Granularity: For one socket 16, 32, 64, 128, 256 or 512 Mbyte

SDRAM modules with ECC can be plugged in but ECC is not functioning. Mix of ECC modules with non ECC modules is possible.

Mix of PC100 and PC133 DIMMs is possible, but all modules will only work at PC100 speed.

Troubleshooting

Message BIOS update

The System BIOS provides optimum support for the processor you have chosen. If the message BIOS update for installed CPU failed

appears the microcode required for the processor inserted must still be loaded. Further information on this is available in the "BIOS Setup" manual on the "Drivers & Utilities" CD provided.

The screen stays blank

If your screen stays blank this may have the following cause:

The wrong RAM memory module has been inserted

- ▶ See the chapter "Main Memory" for information which memory modules can be used.

ACPI S3 (Save-to-RAM) and/or ACPI S4 (Save-to-Disk) doesn't work

This system board is fully compliant for ACPI S3 and S4. Therefore it is PC99 certified by Microsoft.

If you have any problems with ACPI please ensure that all of your components are supporting ACPI S3 and S4.

- Operating system
- Hardware and drivers of controllers (e. g. audio, SCSI controllers).

For further information please refer to <http://developer.intel.com/technology/iapc/involve.htm> .